

Better Src Management with GIT-SVN

Johnny Jacob <jjohnny@novell.com>



Novell®

“I see Subversion as being the most pointless project ever started, because the whole slogan for the Subversion for a while was 'CVS done right'”

- Linus Torvalds



Have you ..

Used CVS / SVN

Frustration in managing multiple tasks

Incomming ! (Grenade - New Urgent task)

Ever wished, you'd go back to yesterday when everything was working.

Ever Wondered : Whose commit broke that feature ? (167 commits to check)

Ever lost a patch ? ;-)



Not about..

DSCM – Distributed Source Code Management.

GIT Internals (Itz wonderfull in there.)

GIT & SVN.



Road to GIT(-svn)

Why ?

Tried **QUILT** for task (patch) management

- Stacked patches.
- Manual marking of files to track.
- Not suitable UI (yeah ! itz for patches).

Tried out **BZR** (Bazaar)

- Slower (when i tried it a year ago)

Step 0.0 - 0.7.2



Step 0.0 – Clone - Setting it up

```
git-svn clone -t tags -b branches -T trunk -r 35350 svn  
+ssh://jjohnny@svn.gnome.org/svn/evolution  
git checkout master
```



Step 0.0 - Clone

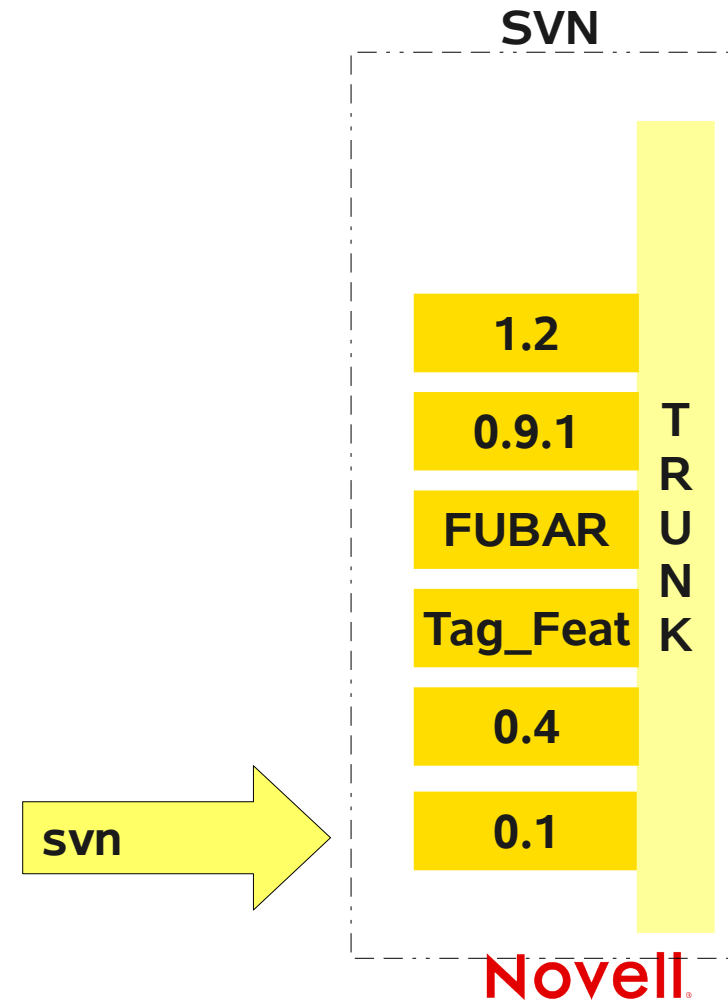

Step 0.0 - Clone

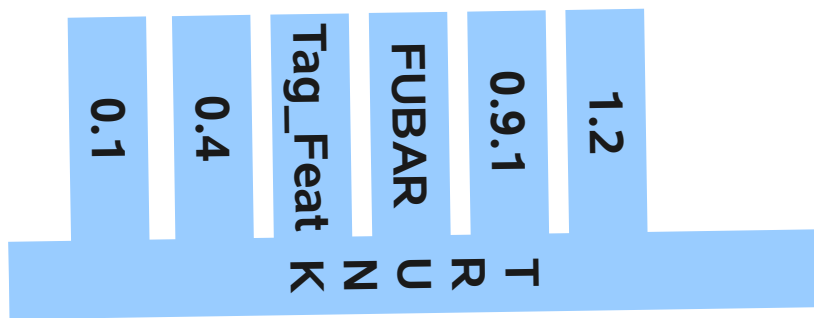

Local Copy

© March 22, 2008 Novell Inc.

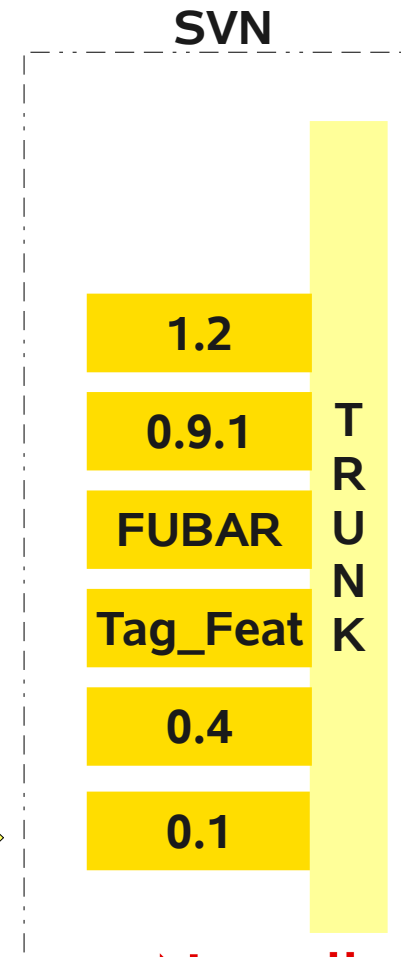

Novell.



Wait a Minute ...

50 Revisions ?

- Evolution Checkout of HEAD (rev 35398) : **229 M**



Wait a Minute ...

50 Revisions ?

- Evolution Checkout of HEAD (rev 35398) - **229 M**
- GIT-SVN (rev 35350 – 35398) - **184 M**
 - git-repack -a -d : 149 M [Pack is **31M**]



Wait a Minute ...

50 Revisions ?

- Evolution Checkout of HEAD (rev 35398) - **229 M**
- GIT-SVN (rev 35350 – 35398) - **184 M**
 - git-repack -a -d : 149 M [Pack is **31M**]

Mozilla repository

- SVN
 - Around **240,000** files.
 - Reported to be almost **12 GB** when stored in SVN.
- Git
 - Only **two** files
 - **420 MiB**

Step 0.1 - Branches

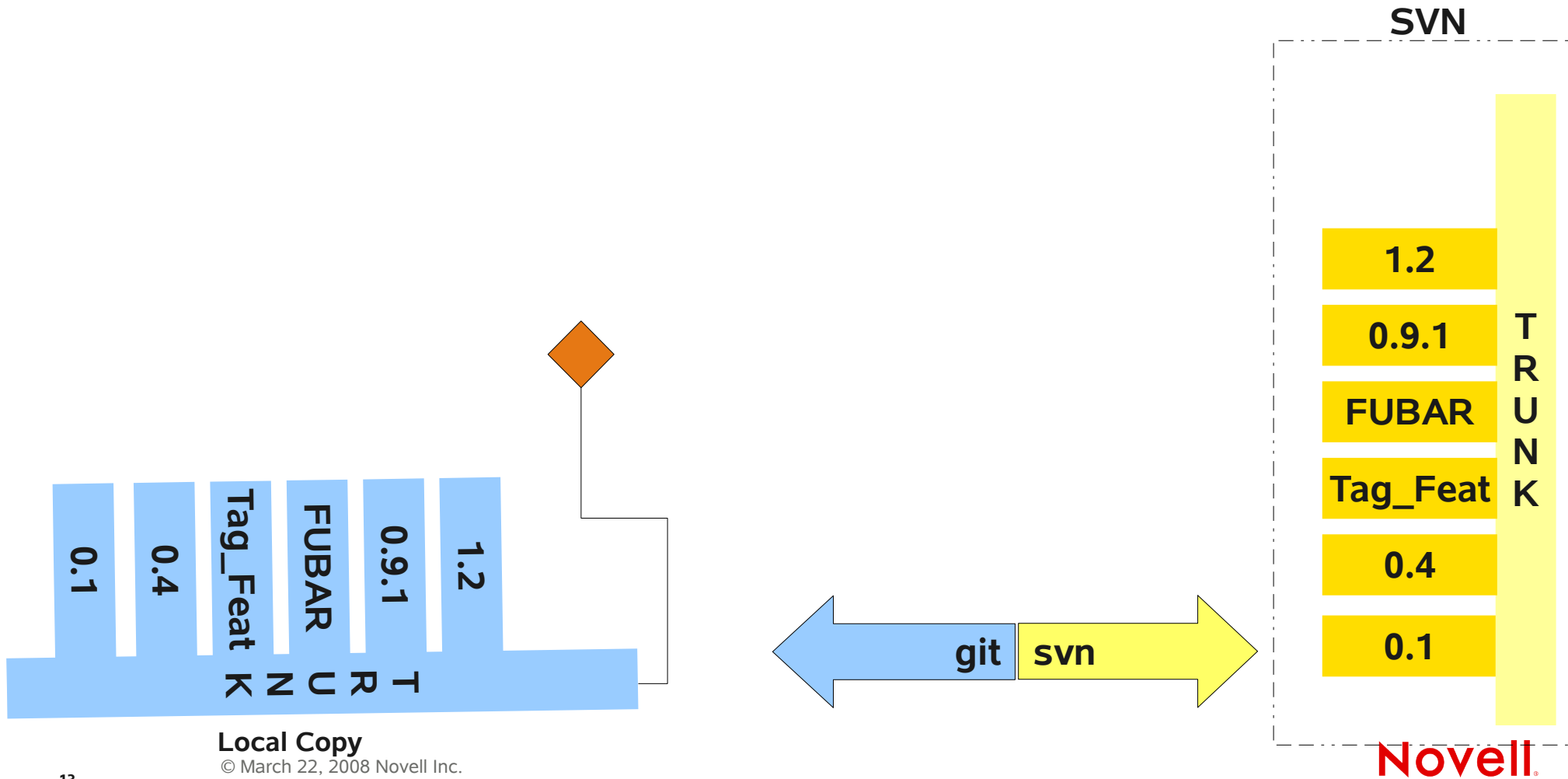

Step 0.1 - Branches

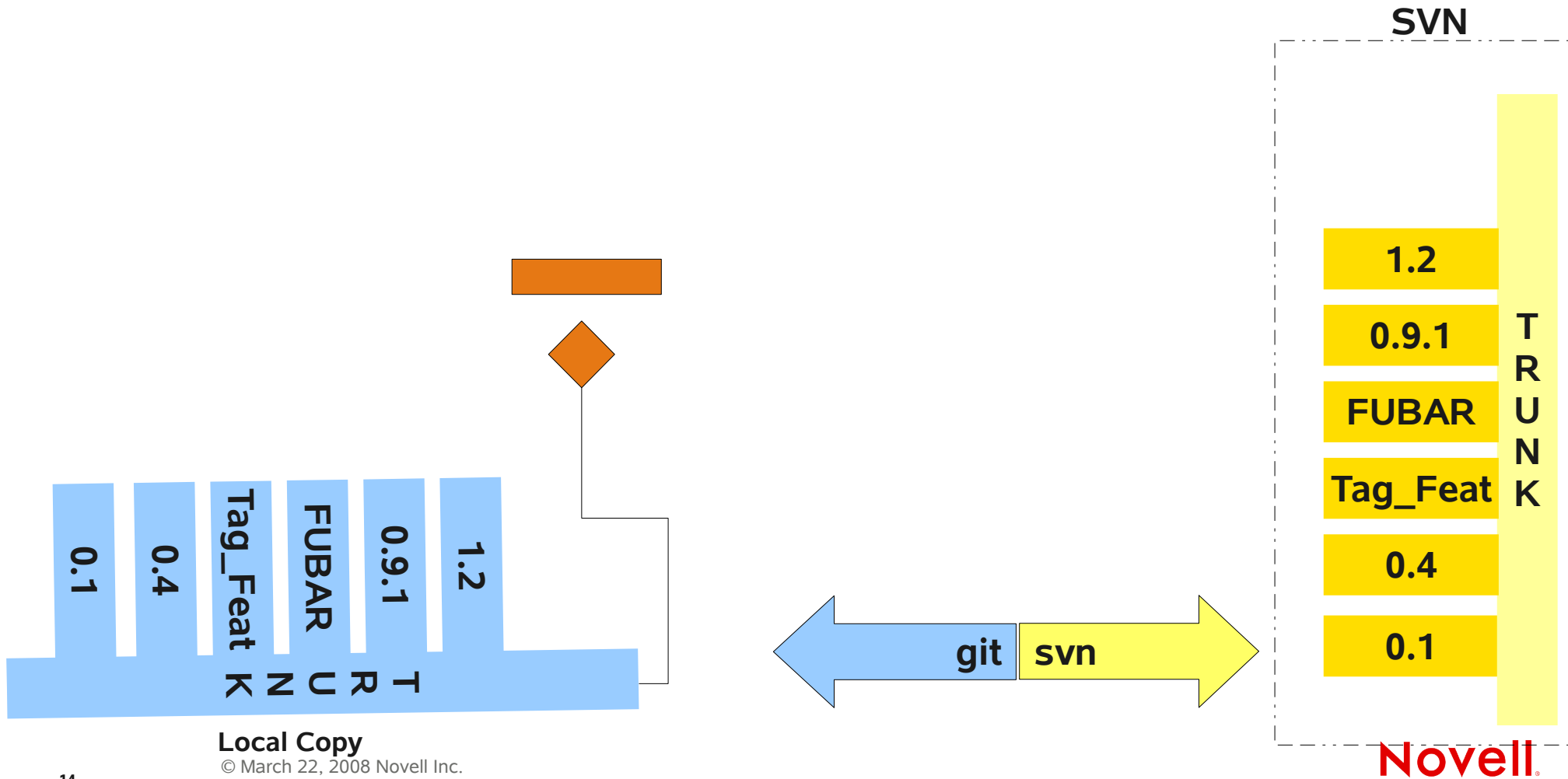

Step 0.1 - Branches

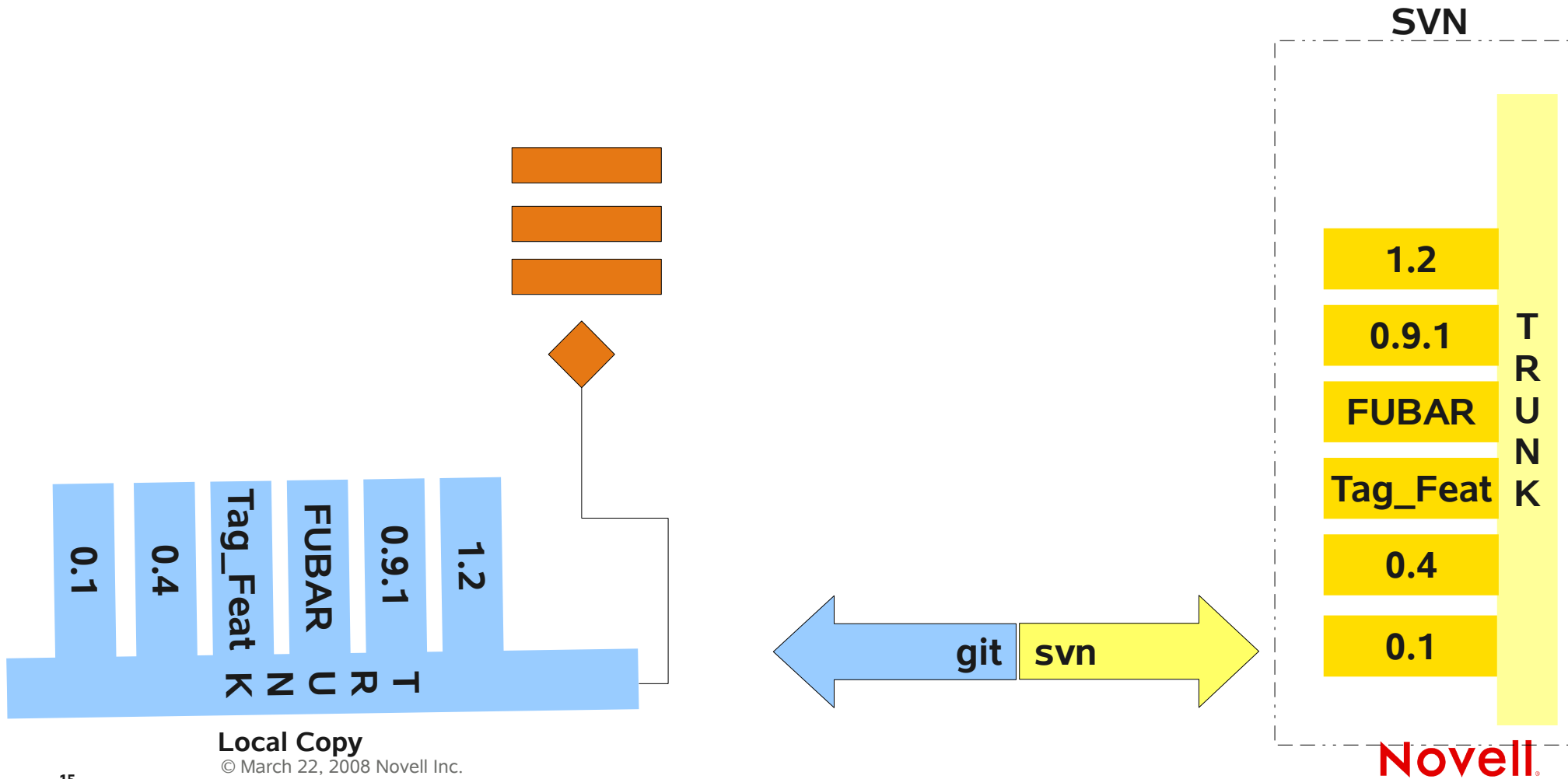

Step 0.1 - Branches

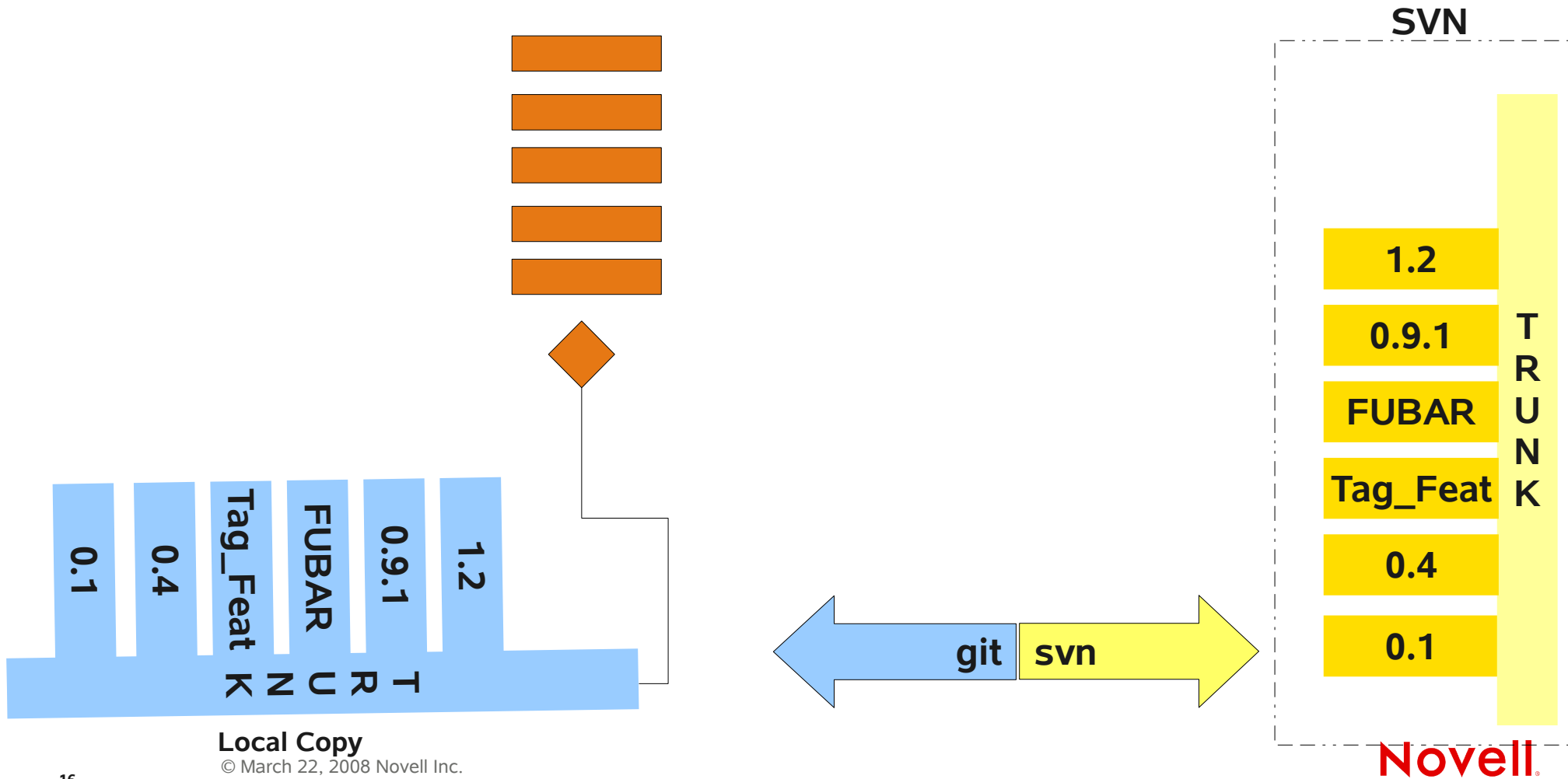

Step 0.1 - Branches

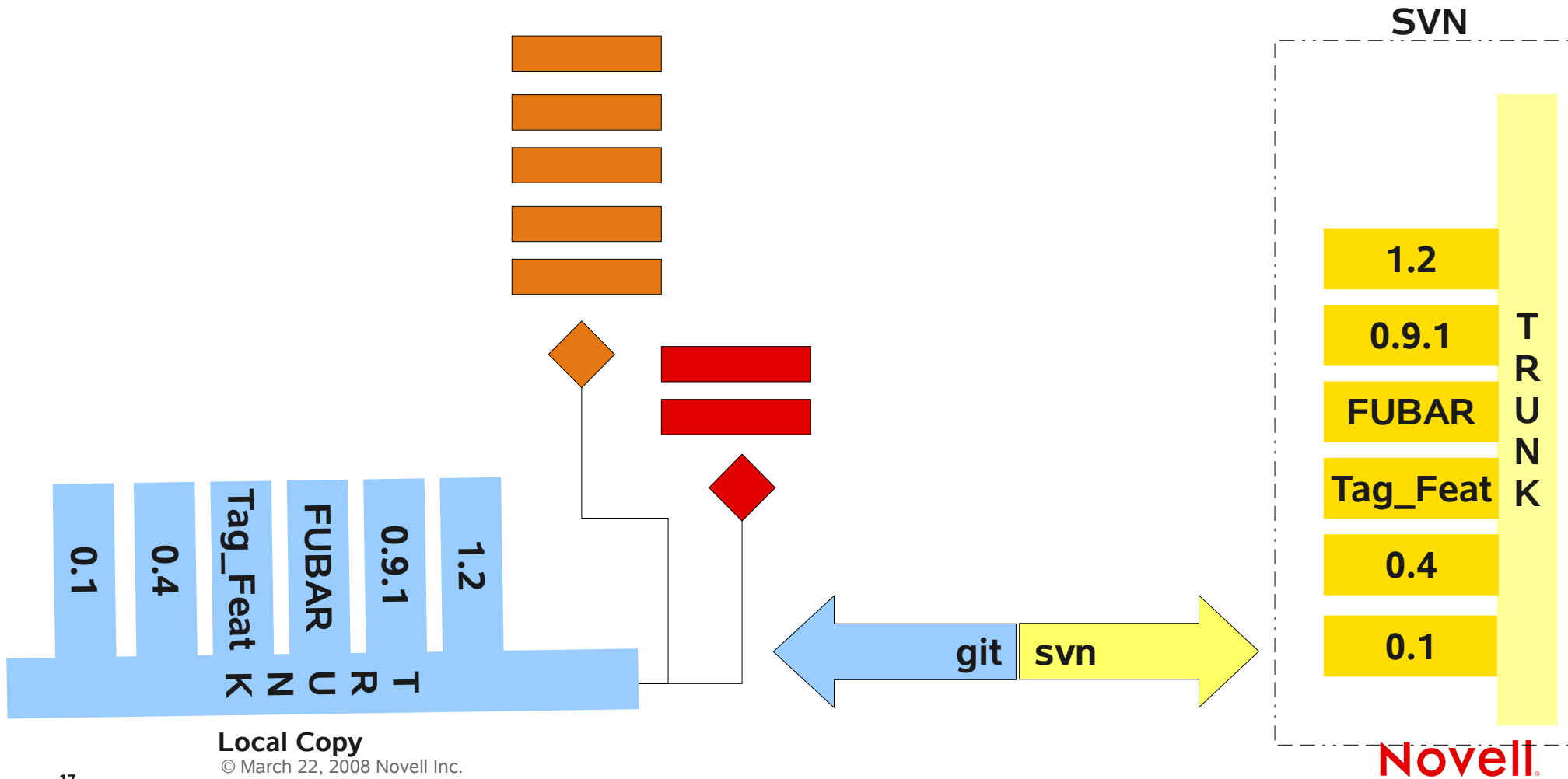

Step 0.1 - Branches

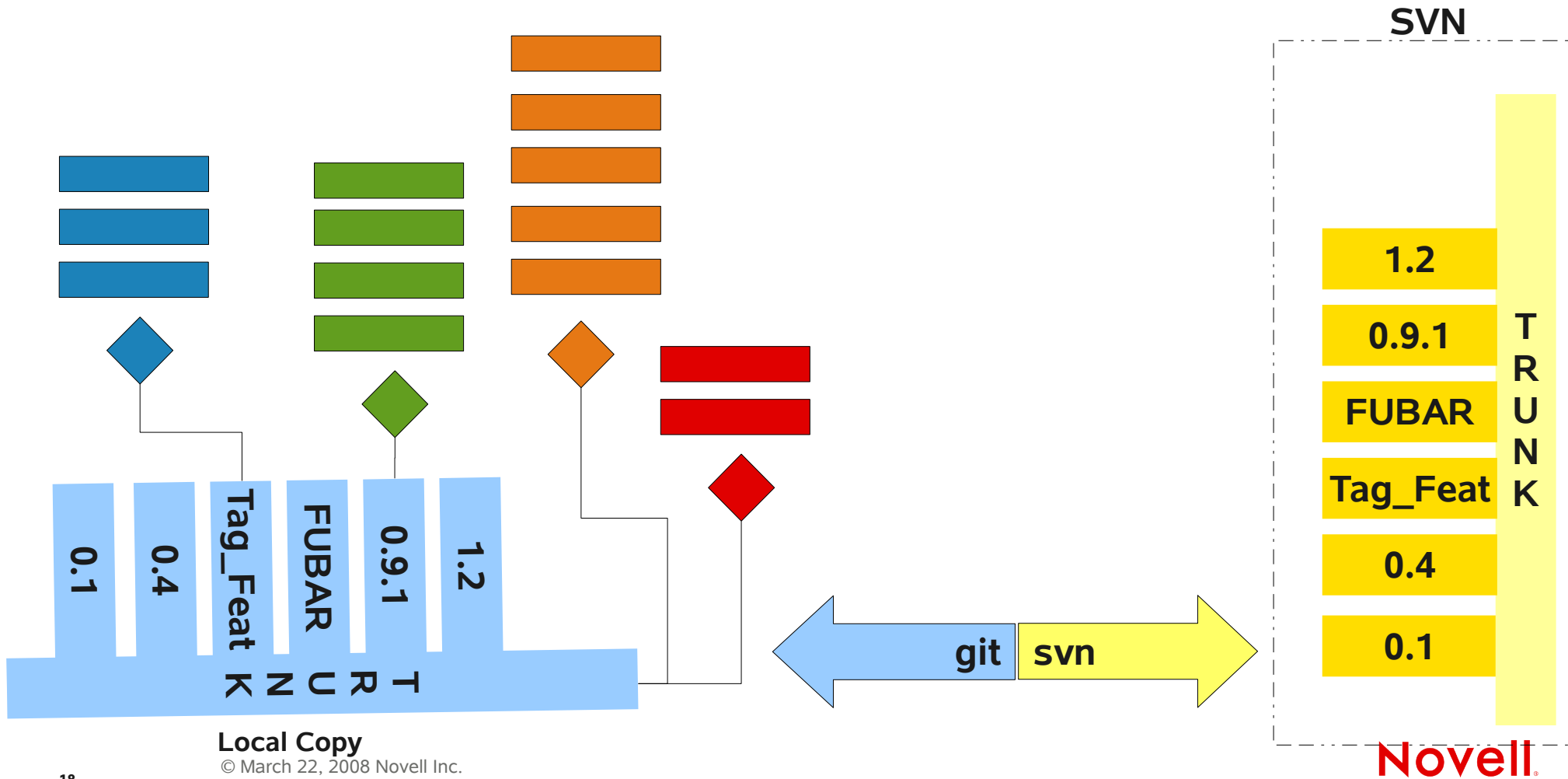



Step 0.1 – Local Branches

`git checkout -b orange-feature remotes/trunk`

- *What is remotes/*?*

Local Commits

- `git status | less`
- `git add Changelog main.c`
- `git commit -a -m "Phase 1 completed. TODO : Cleanups"`

`git checkout -b blocker-red-issue remotes/gnome-2-20`

Step 0.2 - Merging

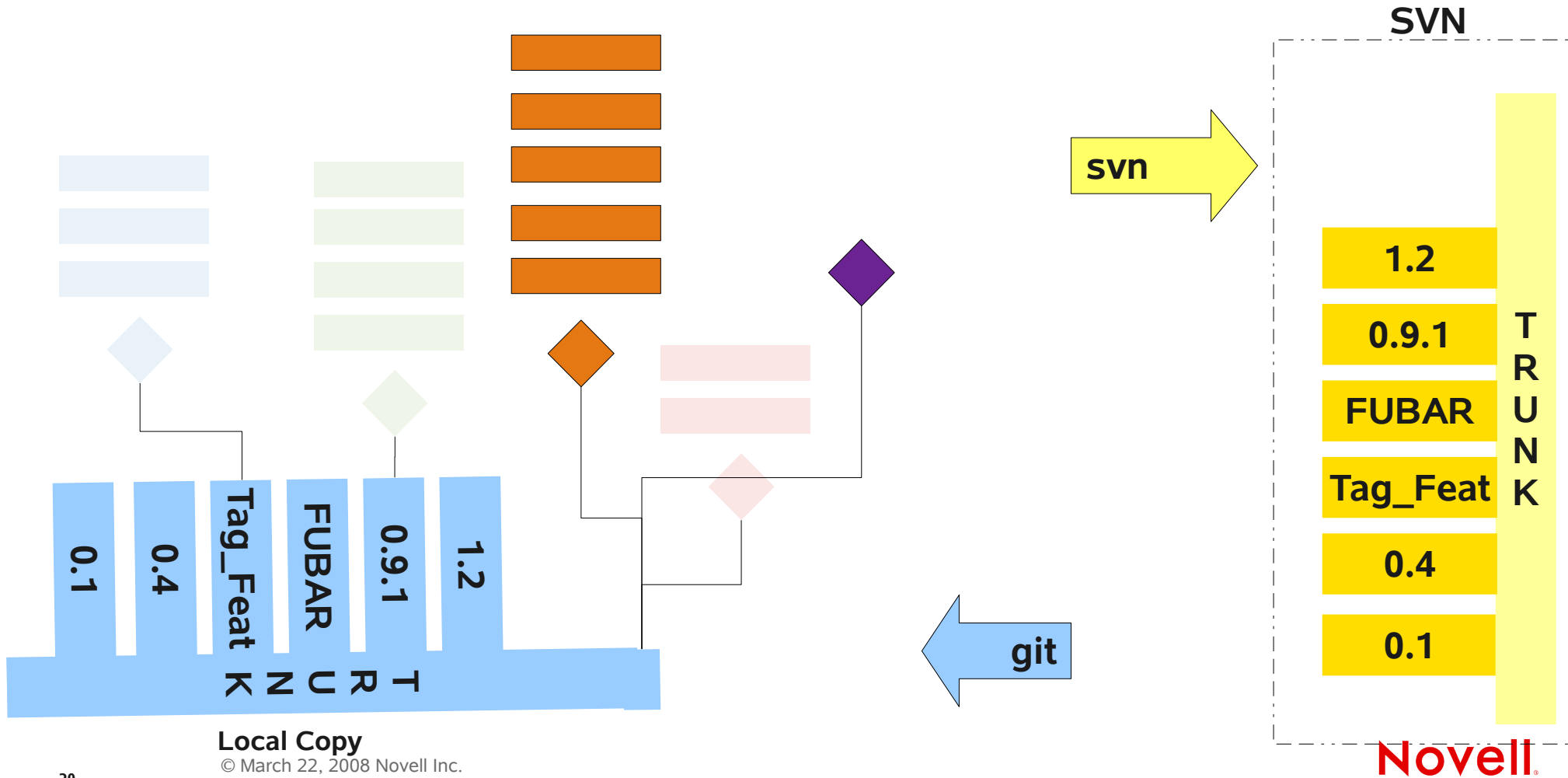

Step 0.2 - Merging

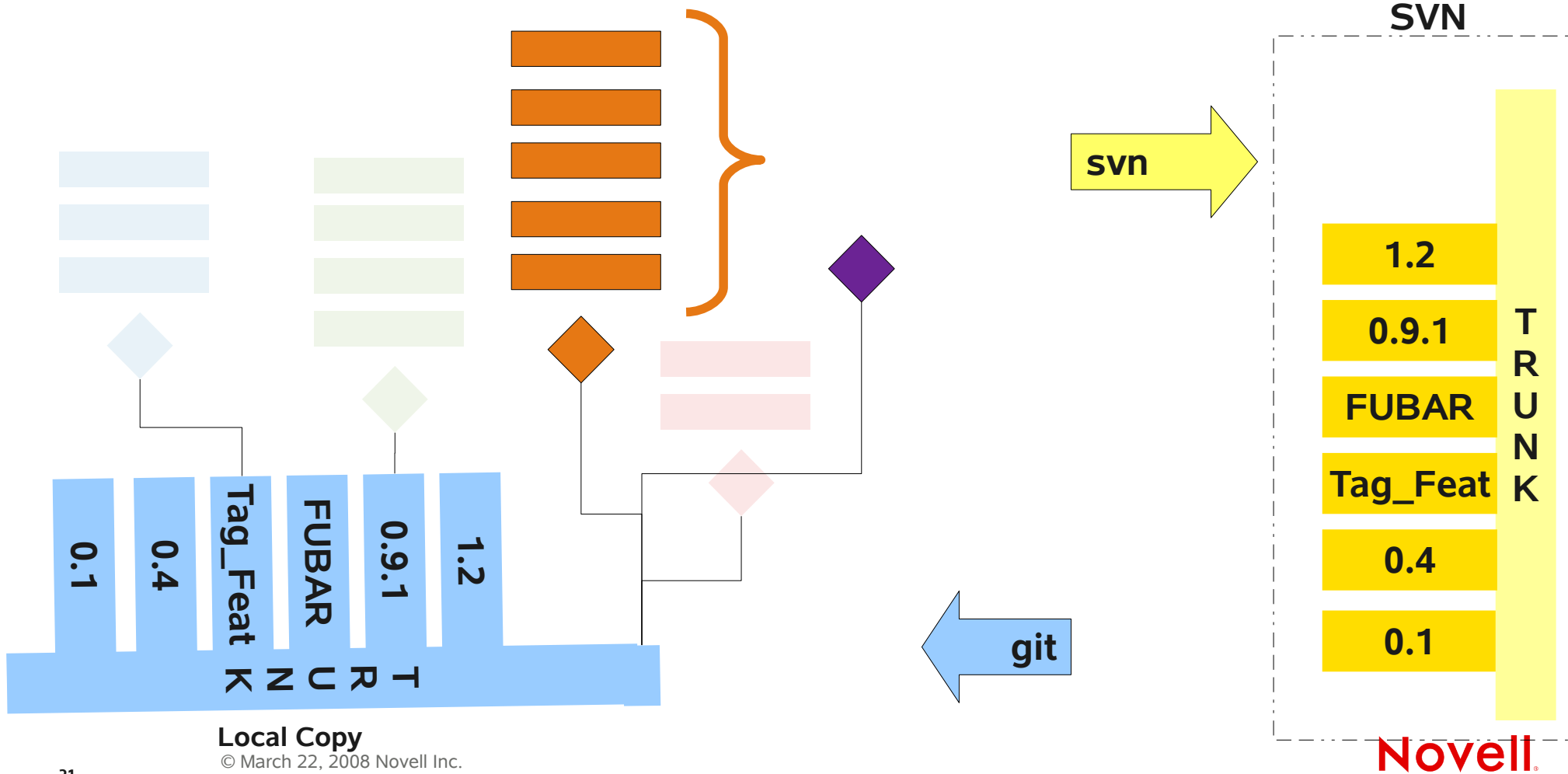

Step 0.2 - Merging

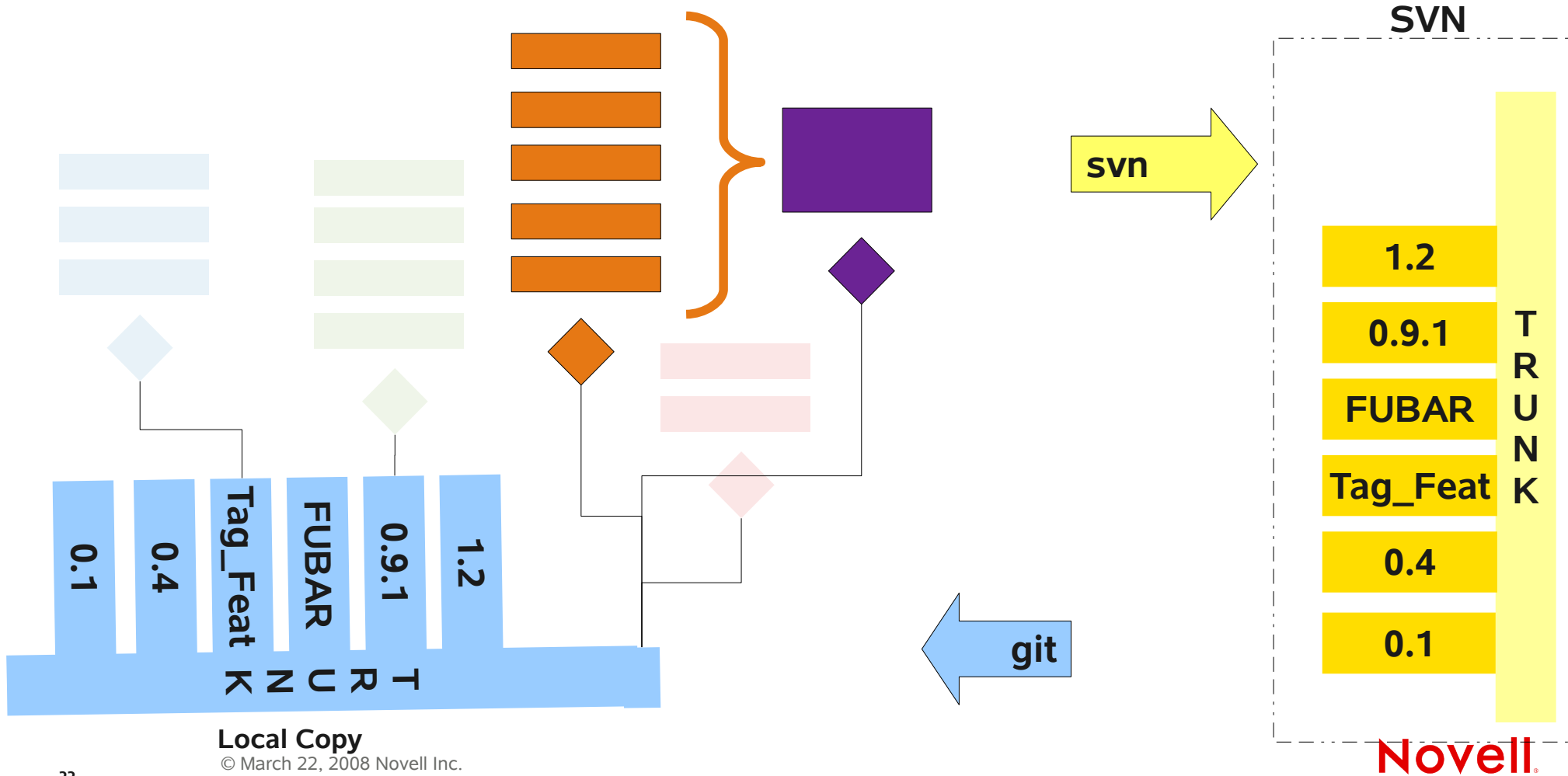



Step 0.2 - Merging

git checkout master

git merge --squash blocker-issue

- *Merged but no committed*
- *Can do final check and commit*

Step 0.3 - DCommit

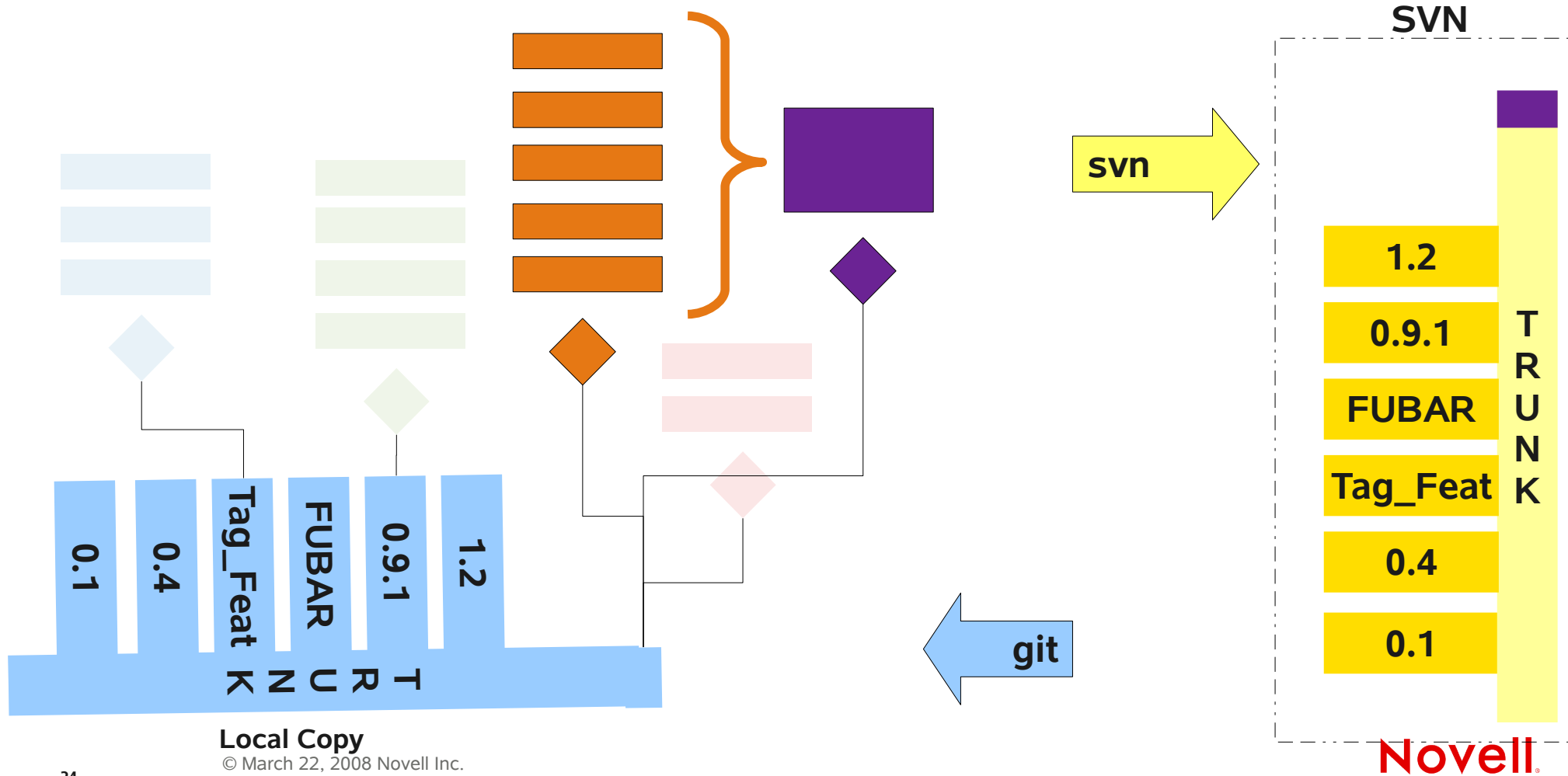

Step 0.3 - DCommit

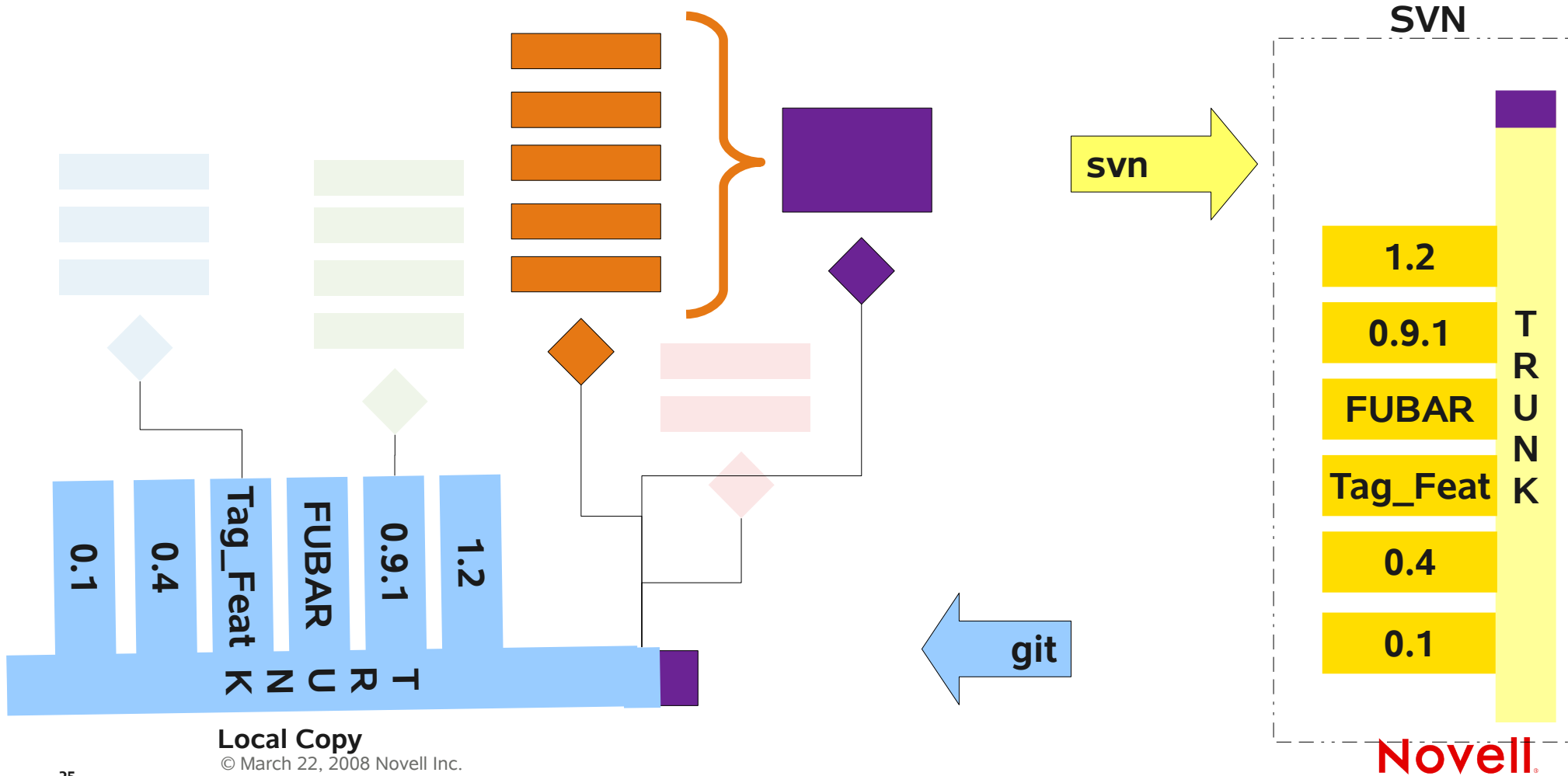



Step 0.3 - DCommit

git-svn dcommit

- *Everything is pushed to SVN.*

Step 0.4 – Updating Code

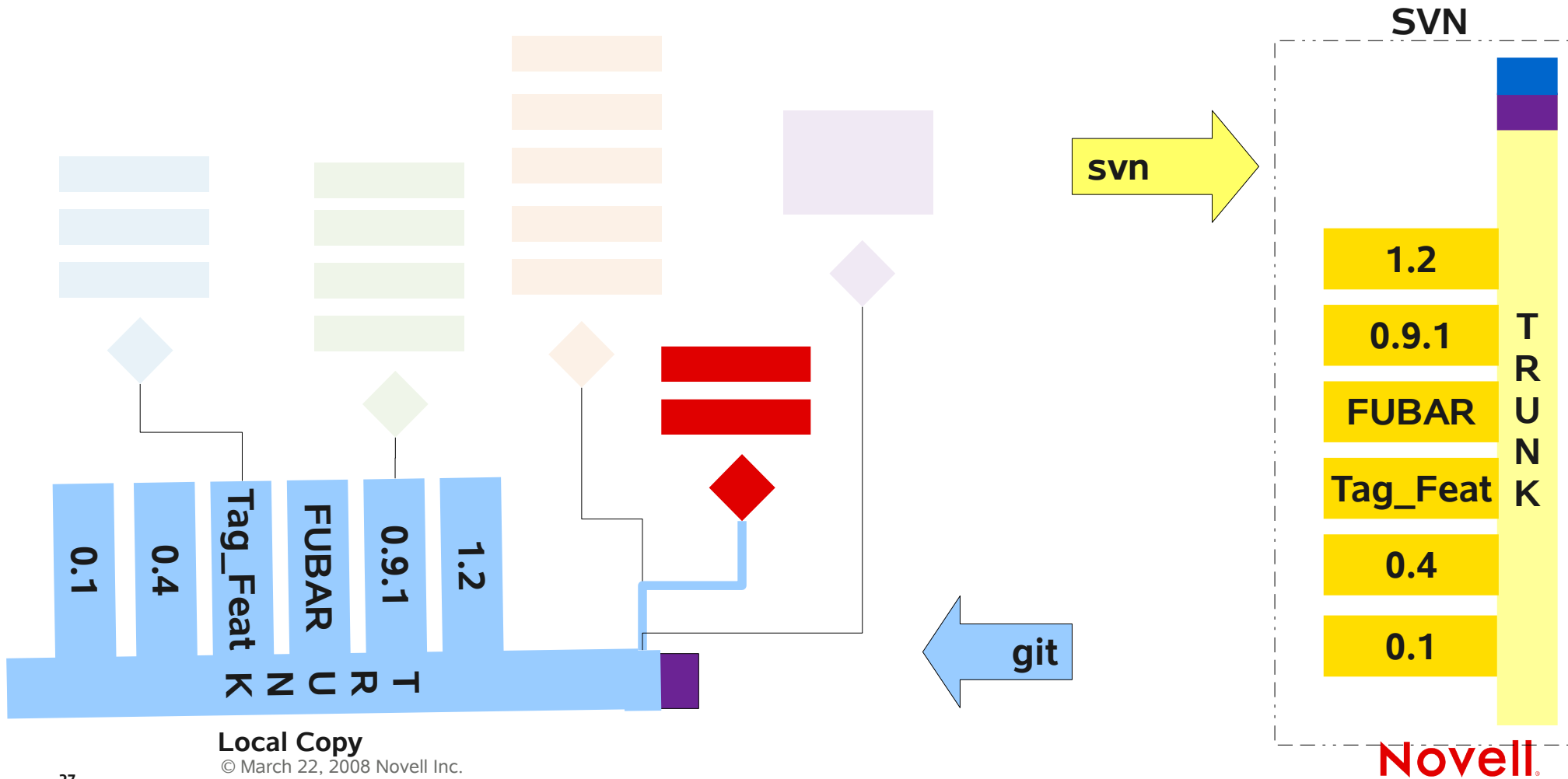

Step 0.4 – Updating Code

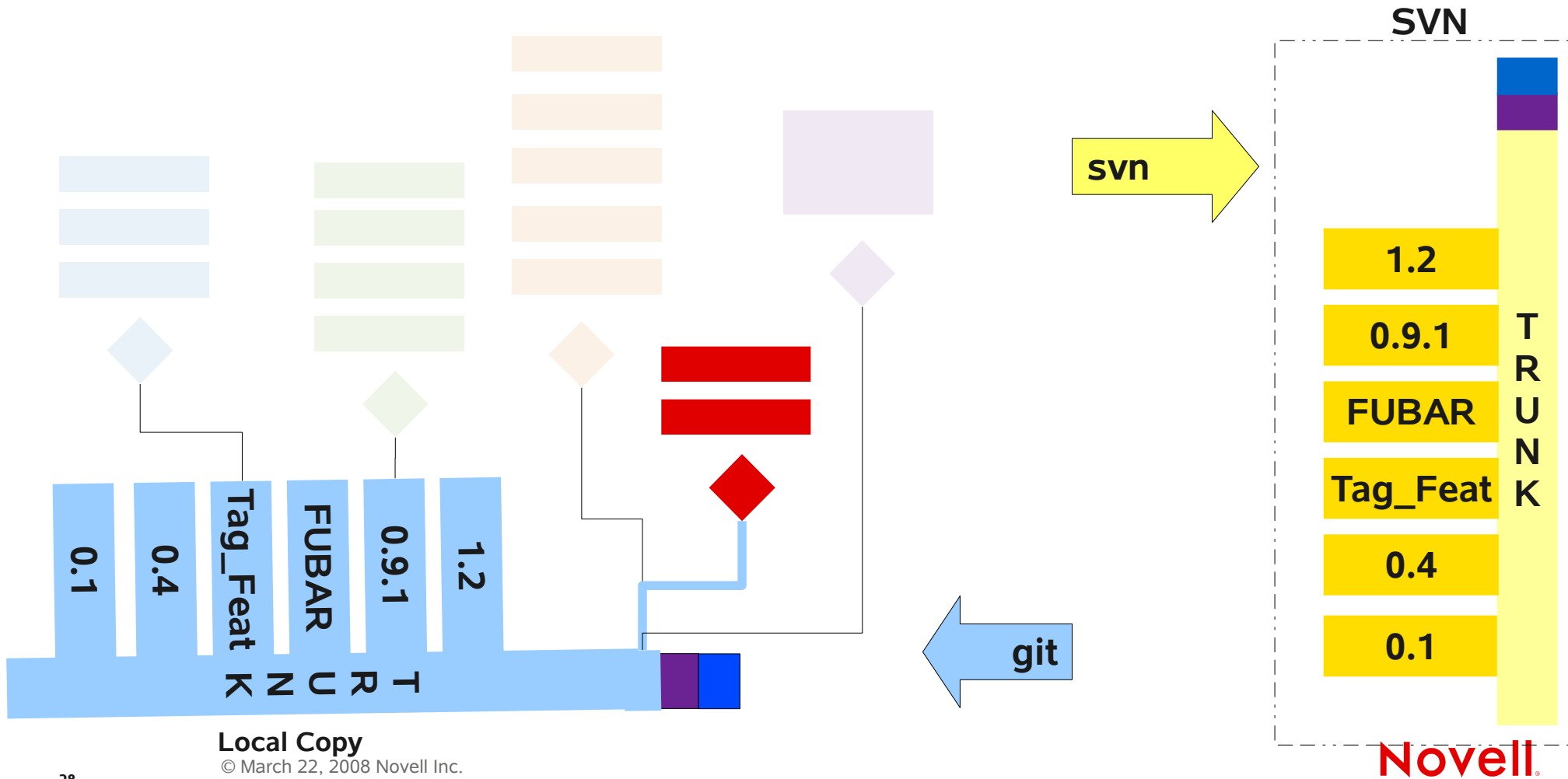

Step 0.4 – Updating Code

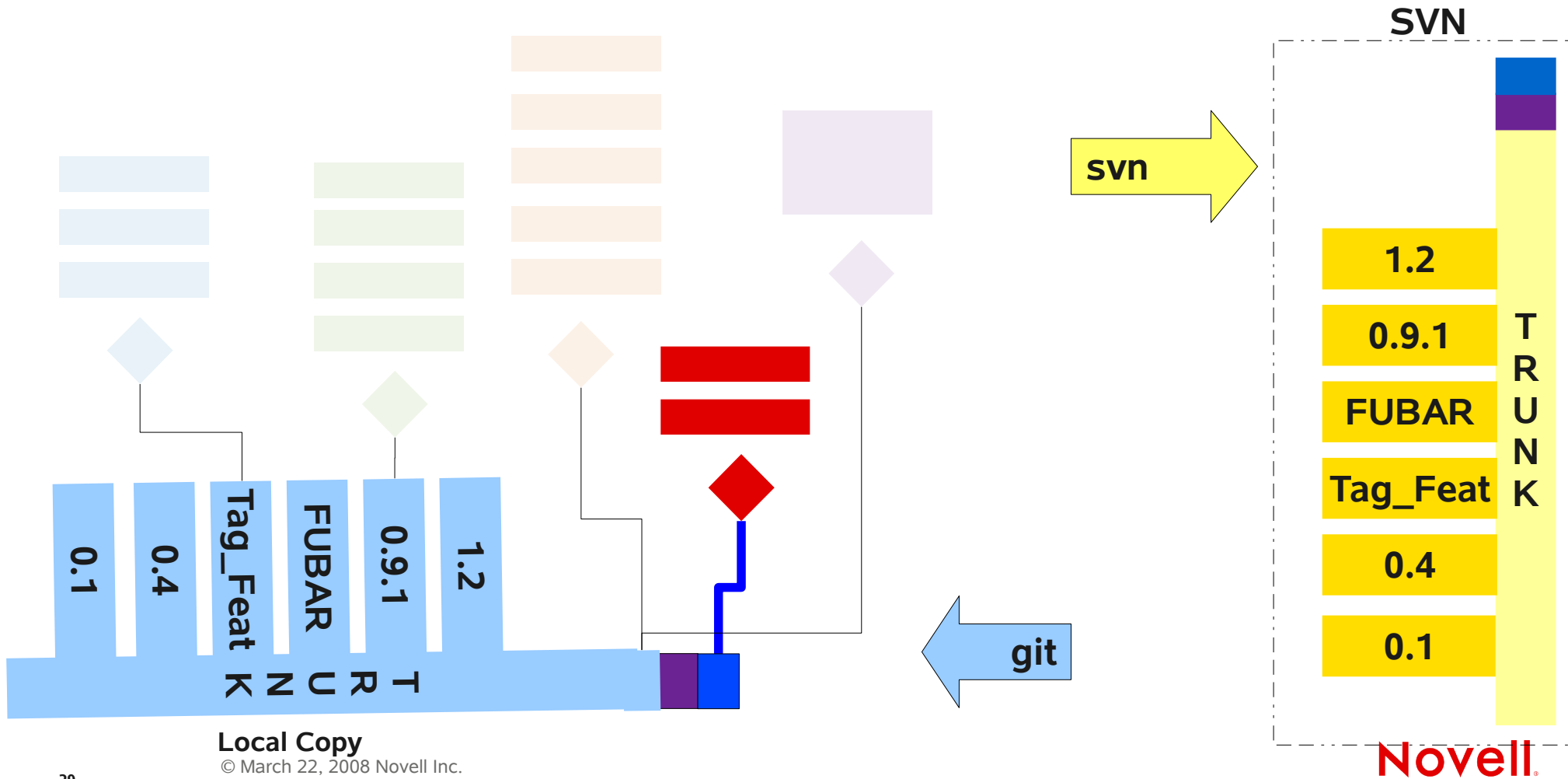



Step 0.4 – Updating Code

git-svn fetch

- *Fetches all the changes*
- *** Your local branches are not changed ***

git rebase master remotes/trunk

- *So you can selectively apply changes.*



Step 0.5 – Deleting Branches

git branch -D orange_feature

- *Deletes the branch orange_feature*



0.7.1 New GIT Repository

Versioning a TarBall.

- Untar.
 - cd my-tarball-src
 - git init
 - git add .
- ***The directory in under GIT!***

Step 0.7.2 - Need another Working Copy

Local & Shared repositories.

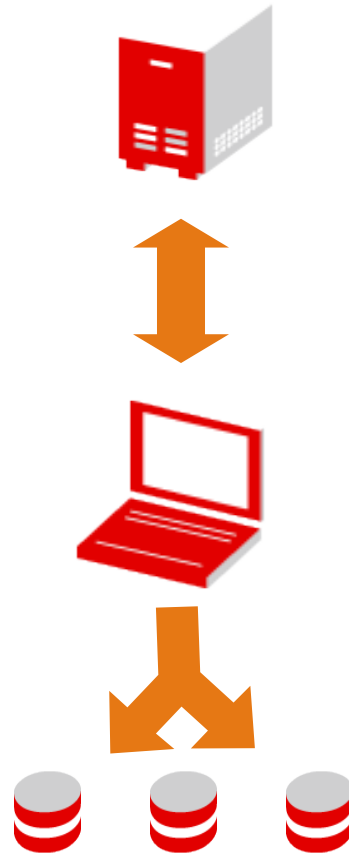



Step 0.7.2 - Need another Working Copy

Local & Shared repositories.

```
git clone --local --shared $HOME/git/project $HOME/git/rewrite
```

- Not a complete clone
- Objects are reused.
- ** Don't delete the local parent **



Step 0.8 Cherry Pick



Step 0.9 Stash / Bisect

git-stash

- Working on “World Peace”
- Disturbed – New BLOCKER ISSUE - “Fix for Bin Laden's insanity”
- Stash away -”World Peace”- and start “Bin Laden's Fix”
- Then come backt o “World Peace”

git-bisect

Gooyey - GUI



Gooyey – GUI - giggle

Project Edit View Go Help

History Summary

- Project
- ▼ /home/jjohnny...
- ▶ addressbook
- ▶ art
- ▶ autom4te...
- ▶ calendar
- ▶ camel
- ▶ docs
- ▶ libdb
- ▶ libdataser...
- ▶ libdataser...
- ▶ po
- ▶ servers
- ▶ src
- ▶ win32
- AUTHORS
- COPYING
- ChangeLog
- ChangeLog~
- HACKING
- INSTALL
- MAINTAIN...

Graph	Short Log	Author	Date
	2008-03-17 Christian Kellner <gicmo@gnome.org>	gicmo	Mon 05:05 PM
	Updated Spanish translation	jorgegonz	Sun 08:24 PM
	2008-03-13 Milan Crha <mcrha@redhat.com>	mcrha	Mar 13 06:18 PM
	2008-03-12 Sunil Mohan Adapa <sunilmohan@fsf.org.in>	smohan	Mar 12 02:15 PM
	2008-03-11 Alexander Shopov <ash@contact.bg>	al_shopov	Mar 11 01:27 PM
	2008-03-10 Matthew Barnes <mbarnes@redhat.com>	mbarnes	Mar 11 08:11 AM
	Updated Spansih translation	jorgegonz	Sun 08:24 PM
	2008-03-13 Milan Crha <mcrha@redhat.com>	mcrha	Mar 13 06:19 PM
	2008-03-12 Sunil Mohan Adapa <sunilmohan@fsf.org.in>	smohan	Mar 12 02:08 PM
	2008-03-11 Priit Laes <plaes at svn dot gnome dot org>	plaes	Mar 12 12:06 AM
	2008-03-11 Alexander Shopov <ash@contact.bg>	al_shopov	Mar 11 12:40 PM
	Make EDS point to libical gnome-2-22 branch.	sragavan	Mar 10 01:49 PM
	Evolution Data Server 2.22.0 release branch	sragavan	Mar 10 01:38 PM
	Evolution Data Server 2.22.0 release tag	sragavan	Mar 10 01:34 PM

▼ Revision information

Date:

SHA:

Change Log:

▼ Differences

Gooyey – GUI - qgit

The screenshot shows the qgit GUI for the /k/git/linux repository. The main window displays a commit log with columns for Graph, Last change, Short Log, and Author. The selected commit is:

Graph	Last change	Short Log	Author
●	8d 19h 58m 36s	[PATCH] sparc32: silence access_ok() warnings	William Lee Irwin III <wli@holomorphy.com>
●	8d 19h 58m 37s	[PATCH] ppc32: add 405EP cpu_spec entry	Eugene Surovegin <ebs@ebshome.net>
●	8d 19h 58m 37s	[PATCH] uml: clean up error path	Jeff Dike <jdike@addtoit.com>
●	8d 19h 58m 37s	[PATCH] uml: fix strace -f	Jeff Dike <jdike@addtoit.com>
●	8d 19h 58m 37s	[PATCH] uml: compile fixes for gcc 4	Jeff Dike <jdike@addtoit.com>
●	8d 19h 58m 38s	[PATCH] uml: make the emulated iomem driver work on 2.6	Jeff Dike <jdike@addtoit.com>
●	8d 20h 13m 34s	Merge rsync://rsync.kernel.org/pub/scm/linux/kernel/git/aegl/linux-2.6	Linus Torvalds <torvalds@ppc970.osdl.org>
●	8d 21h 8m 30s	[PKT_SCHED]: Fix numeric comparison in meta ematch	Thomas Graf <tgraf@suug.ch>
●	8d 21h 8m 47s	[PKT_SCHED]: Dump classification result for basic classifier	Thomas Graf <tgraf@suug.ch>
●	8d 21h 9m 1s	[PKT_SCHED]: Allow socket attributes to be matched on via meta ematch	Thomas Graf <tgraf@suug.ch>
●	8d 21h 9m 27s	[PKT_SCHED]: Fix typo in NET_EMATCH_STACK help text	Thomas Graf <tgraf@suug.ch>
●	8d 21h 23m 48s	[NET]: Fix sysctl net.core.dev_weight	Stephen Hemminger <shemminger@osdl.org>

The selected commit details are shown below the log:

```

Author: Thomas Graf <tgraf@suug.ch>
Date: 06/08/2005 04:11:02 PM
Parent: 4890062960cbc4d3cebdbd8261a68bc85efcf5d4

[PKT_SCHED]: Dump classification result for basic classifier

Signed-off-by: Thomas Graf <tgraf@suug.ch>
Signed-off-by: David S. Miller <davem@davemloft.net>
  
```

The diff view for the selected commit is shown in a separate window:

```

Diff to:  Parent  HEAD  SHA
e1e284a4bd827db2288af9536664b44590e419eb (from
4890062960cbc4d3cebdbd8261a68bc85efcf5d4)
diff -git a/net/sched/cls_basic.c b/net/sched/cls_basic.c
--- a/net/sched/cls_basic.c
+++ b/net/sched/cls_basic.c
@@ -261,6 +261,9 @@ static int basic_dump(struct tcf_proto *
    rta = (struct rtattr *) b;
    RTA_PUT(skb, TCA_OPTIONS, 0, NULL);

+   if (f->res.classid)
+       RTA_PUT(skb, TCA_BASIC_CLASSID, sizeof(u32), &f->res.classid);
+
    if (tcf_exts_dump(skb, &f->exts, &basic_ext_map) < 0 ||
        tcf_em_tree_dump(skb, &f->ematches, TCA_BASIC_EMATCHES) < 0)
        goto rta_failure;
  
```

Publishing



GIT Hosting

Easy - git-push

- `git push --force --all`
`ssh://www.example.com/~username/public_html/git/myproject.git`

Hosting Services

- Gitorious.org
- Github.com
- `http://any.webserver/.git`



So now .. When you ..

Used CVS / SVN Working knowledge

- **Naah .. Move on !!**

Frustration in managing multiple tasks

- **Use local branches**

Ever wished, you'd go back to yesterday when everything was working.

- **Local Commits – Commit whenever you feel like!**

Ever Wondered : Whose commit broke that feature ? (167 commits to check)

- **Git-Bisect**

Ever lost a patch ? ;-)

- **Easy Publishing / Sharing (Next Talk ;-)**



Trivia

Why name GIT.

- Linus : “can mean anything, depending on your mood”
 - Global information tracker
 - Goddamn idiotic truckload of sh*t
 - British slang for "silly, stupid, or worthless person"

Maintained by WHO

- Junio C Hamano.

<http://git.or.cz/gitwiki>



Glossary

index / cache

working copy



Other Tools

- **BitKeeper** (bk)
- **GNU Arch** (tla)
- **ArX** (arx) — started as fork of Arch, written in C++.
- **Bazaar-NG** (bzd)
- **Monotone** — full-decentralized in a P2P way.
- **Mercurial (hg)** — written in Python. Extremely fast, lightweight, portable, and easy to use.
- **Codeville** written in Python — Uses an innovative merging algorithm.
- **Darcs** is a decentralized and free revision control system written in the Haskell language can keep track of inter-patch dependencies using a "theory of patches" with roots in quantum mechanics.
- **SVK** is written in Perl — built on top of Subversion to allow distributed commits.

Questions ?

Use Google !

